

18-04-2012

AJ

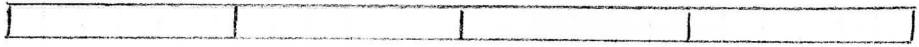

WEGKAPEL 1:87

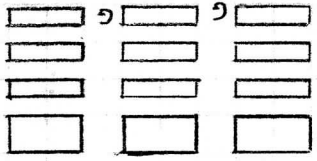
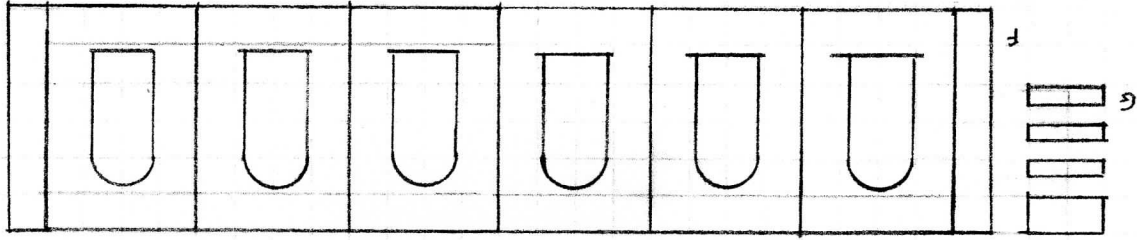
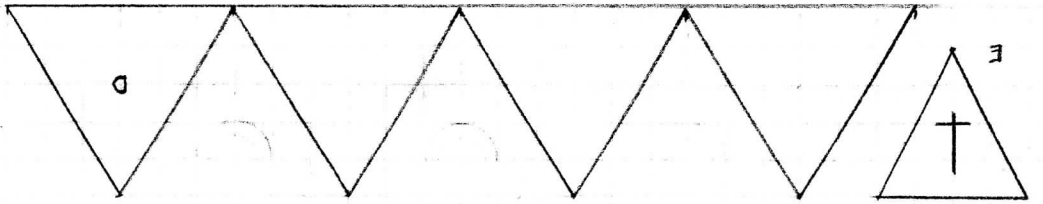
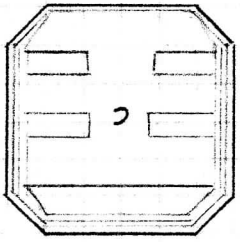
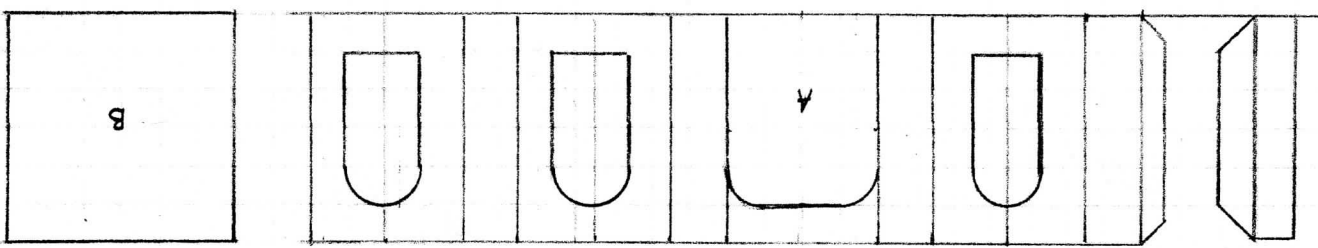
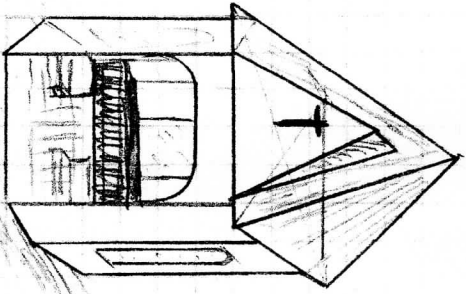

A: BÜTENGEREL  
 B: DAK/PLAFOND  
 C: BODEMPLAAT  
 D: SCHIJD DAK  
 E: "  
 F: BINNEN/GEVEL  
 G: KNIJEBANKJES

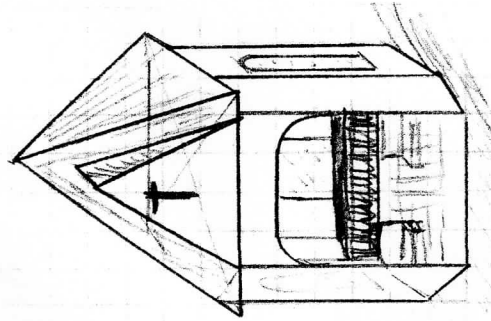

WEGKAPEL 1:87

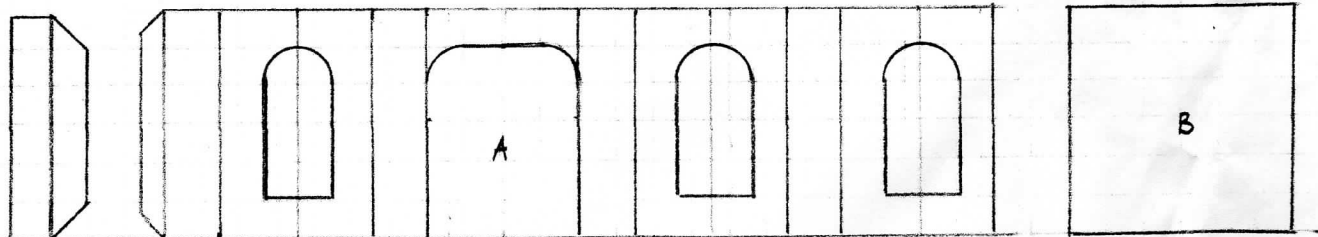
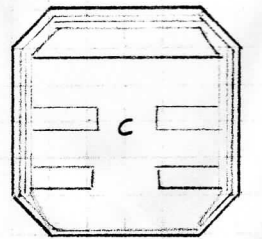
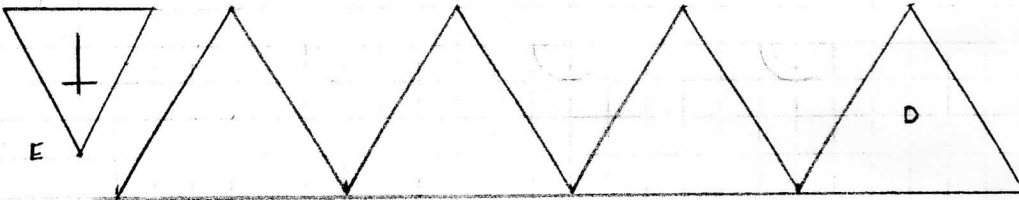
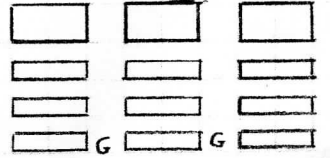
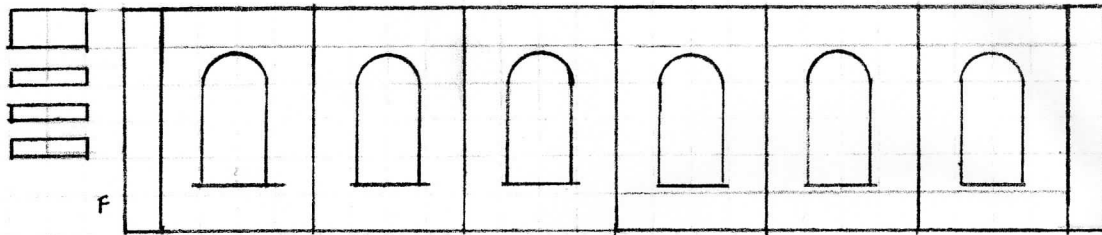
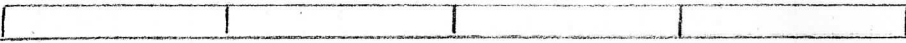

AJ

18-04-2012